



POWER SERIES

UNDERWATER AND HARSH ENVIRONMENT CONNECTORS

The Power series offers a high-performance, dependable connector solution to accommodate the ever growing power requirements of underwater system operators and industries. The series comprises five standard connectors, supported by a number of custom-made solutions.

All based on the connector and contact design, the Power series includes a single contact power connector, three battery charging connectors (2, 3 and 4 contacts) and a 4-contact high power connector. The single contact power connector is designed for use with a selection of cable sizes and can be operated at up to 3 kV and 250 A. The battery charging connectors are suitable for carrying up to 25 A per contact. The 4-contact high power connector is suitable for 600 V at 50 A per contact and is supplied in standard inline and bulk-head configurations.

For easy integration with systems and equipment, Power series connectors are available with dedicated cables, polyoxymethylene (POM) or stainless steel locking sleeves and pressure-proof dummy connectors. All standard cables for the S Power series are of the flexible and water-resistant chloroprene rubber.

Applications

Power supply for offshore oil and gas, renewable energy and subsea systems

Power supply for remotely operated vehicles (ROV) and subsea trenching machines

Marine battery pack charging

Power supply for underwater pump units

Hazardous environment power supply

Options

Customised harness cables and direct moulding to compatible polyurethane (PUR) cables

Customer specified connector body material and cable lengths

Field installable versions for all Power series connectors



OUR ADVANTAGES



EASY SOLUTIONS

ADAPTABILITY IS ONE OF OUR BEST QUALITIES. IT PERMIT US TO COPE WITH YOUR REQUEST ON A SHORT NOTICE AND EFFECTIVELY.



NO PRICE FIGHTS

WE ESCAPED THE CLASSICAL "REBATE UNTIL YOU DROP" POLICY. WE ARE PRICE WISE SINCE THE BEGINNING.



HIGH LEVEL EXPERIENCE

OUR TECHNICAL CAPABILITIES HAVE BEEN TESTED FOR MORE THAN 30 YEARS AND IN DIRECT CONNECTION WITH END USERS. SO TO SAY.



ENDLESS INVESTIGATION

WE CONTINUOUSLY MEASURE EVERYTHING. TEST, TEST AND TEST AGAIN. THIS HELPS US UNDERSTAND RISKS AND REWARDS, AND BE PREPARED.



NO FORTUNE TELLER

WE BASE OUR DECISIONS ON CLEAR BUSINESS PLANS, THINKING BEFORE MAKING OUR STEPS AND KEEPING A 'NOT TO DO' LIST FOR EVERYONE OF THEM.



TEAM BUILDING

OUR TEAM IS MADE NOT ONLY BY OUR STAFF BUT IT INCLUDES ALSO ALL OUR CUSTOMERS. WE ACT LIKE A TEAM. WE GROW LIKE A TEAM. WE WIN LIKE A TEAM.

APPLICATION

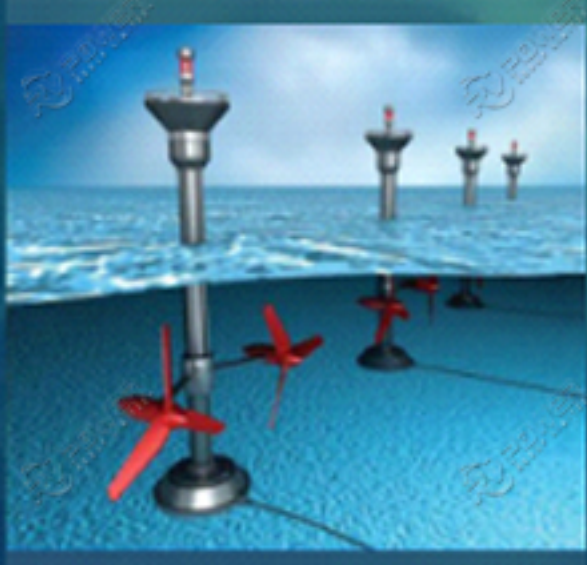

Marine Renewable Energies



Diving



Oil and Gas



Towed Streamers



Submarines



Water Treatment

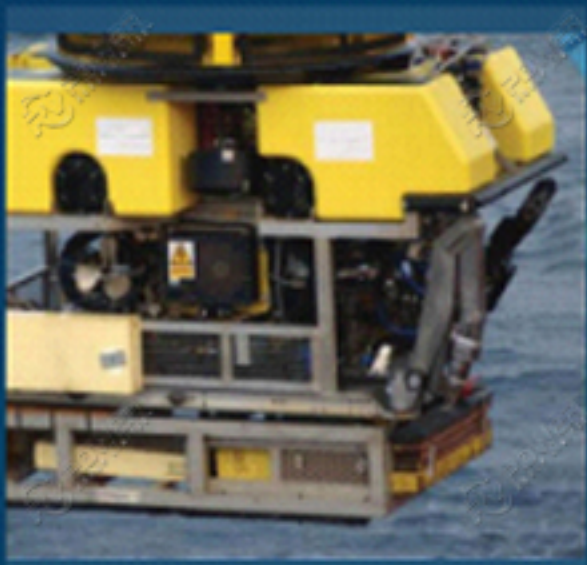

ROVs & AUVs



Vessels



Geophysics

POWER - 1 CONTACT

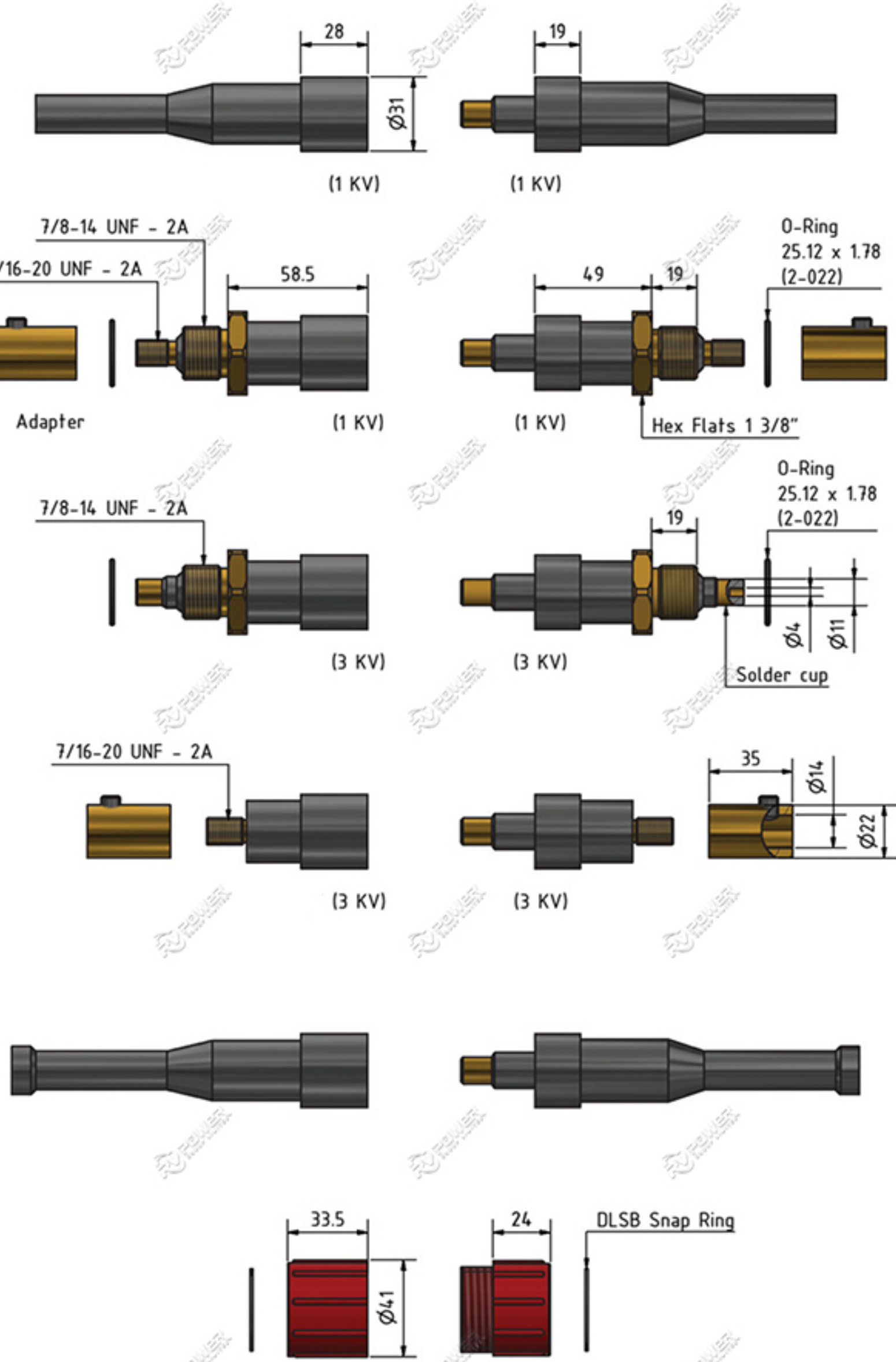

POWER BATTERY 2,3 AND 4 CONTACTS

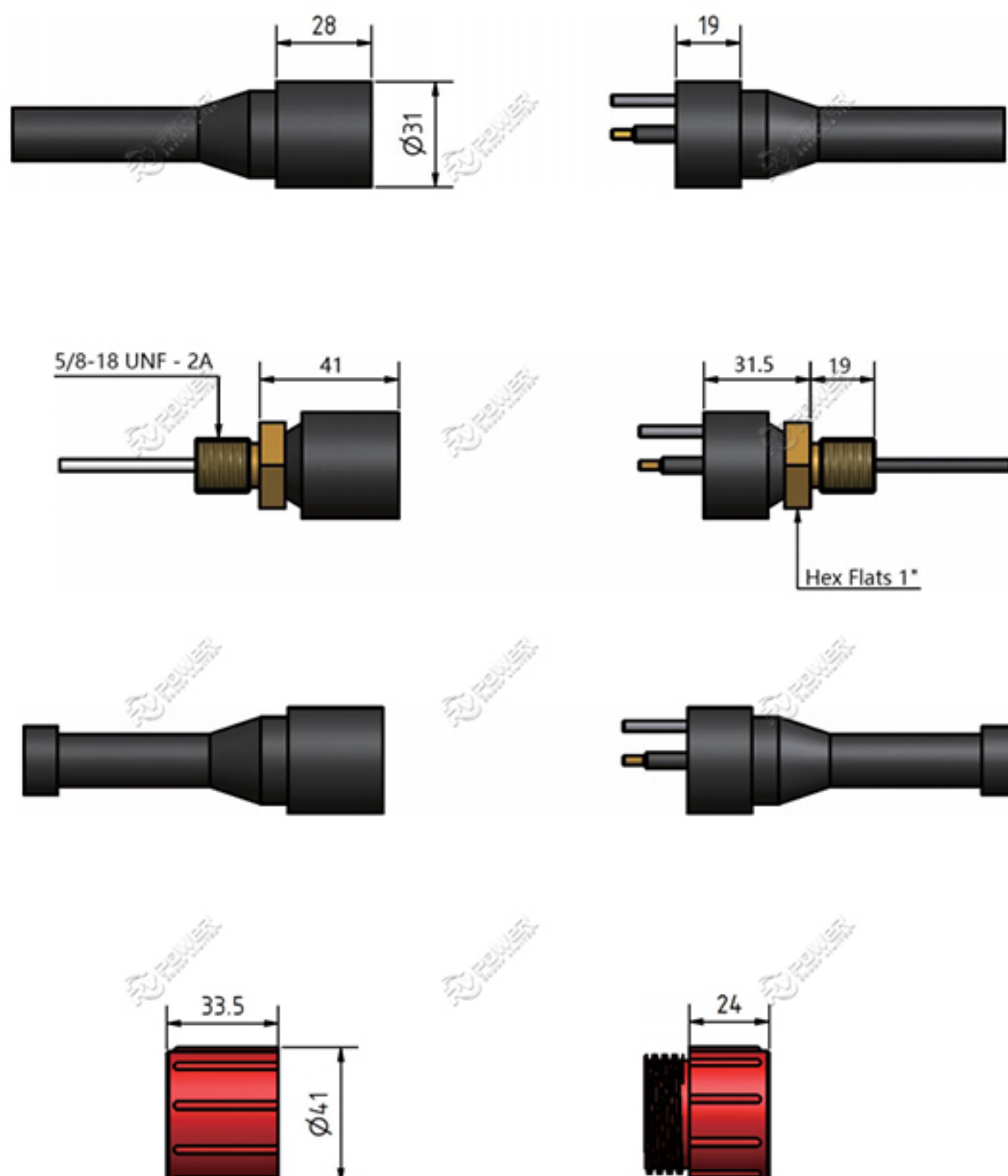

HIGH POWER 4 CONTACTS

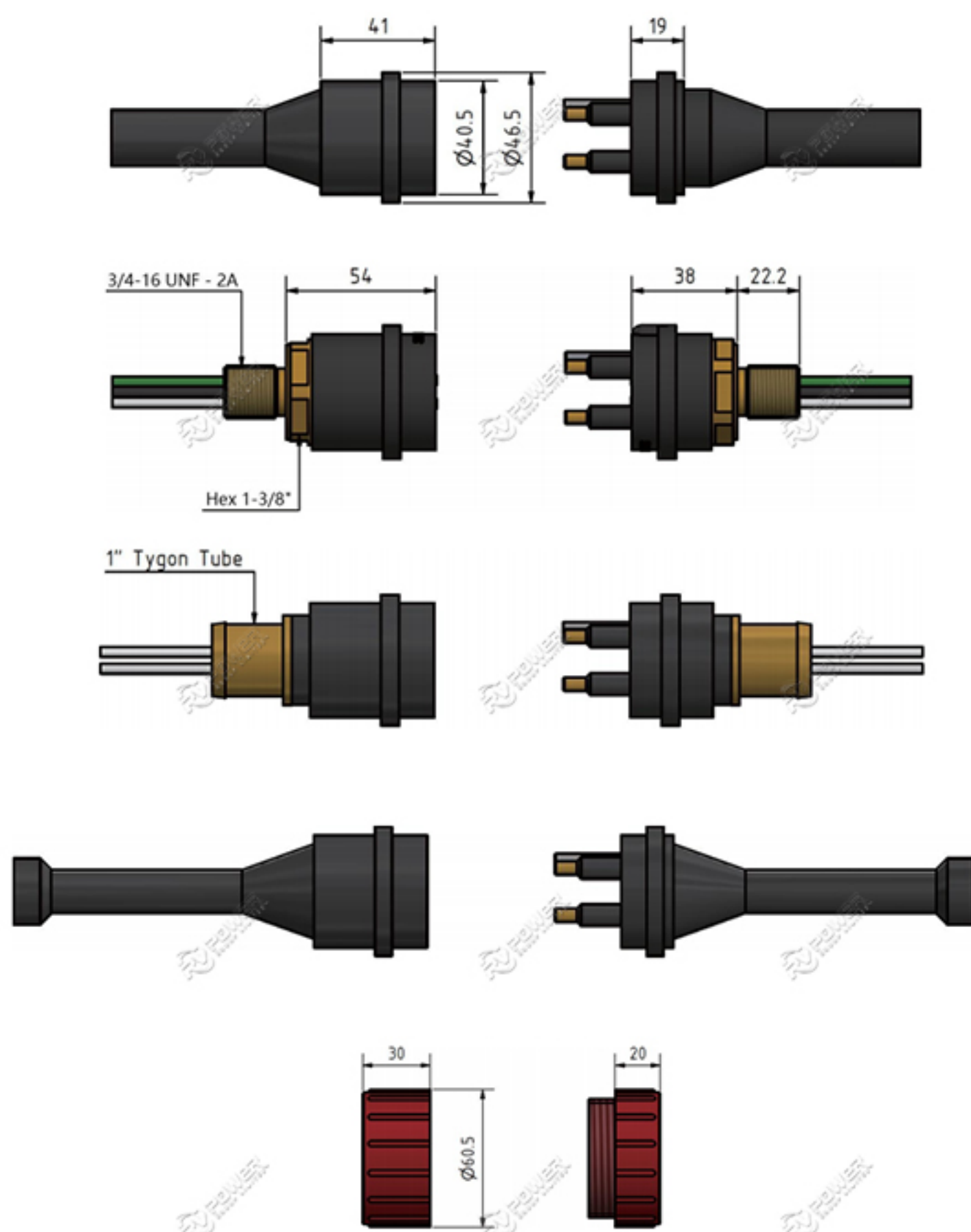

SUBSEA CONNECTORS AND SUBSEA CABLES

RV POWER GROUP is a underwater connector factory in China. We are a global supplier focusing on the ocean (marine) solution for underwater connectors and cables. Specializing in the design, manufacture, sales and service. If your project is in the design stage, we can provide engineering assistance with the professional advice. If your requirements are already specified and ready for quote, we will try our best to meet your deadlines and pricing targets and finally deliver the high-quality stable products as you need.

RV POWER GROUP subsea connectors and subsea cables are suitable for oceanographic systems, offshore oil and gas, defense systems, geo-seismic research, diving systems and equipment, ship projects, subsea survey, underwater instruments, mining equipment, underwater monitoring/inspection/observations, underwater data logger, subsea navigator, hydrography equipment, aquaculture farm and services inspection, underwater robotics like remote operation vehicles (ROV's & ROTV's) and autonomous Underwater Vehicles (AUV), and submarines, ship towed sonars and underwater acoustic devices, etc.

With the state-of-the-art technology and professional engineer team, we believe you find the right partner here with excellent service. In case you do not find a suitable solution within our standard range, please do not hesitate to contact us for customization.

Underwater and harsh environment connectors

Circular Series

Micro Circular Series

Low Profile Series

Micro Low Profile series

Ethernet Series

Optical fiber and Power Series

Power Series

Split Series

Aviation plug Series

Coax series

Metal Shell series

RMG Series

55 Series

Specials Series

Underwater PUR Cable

ROV Tether Cable

Additional accessories

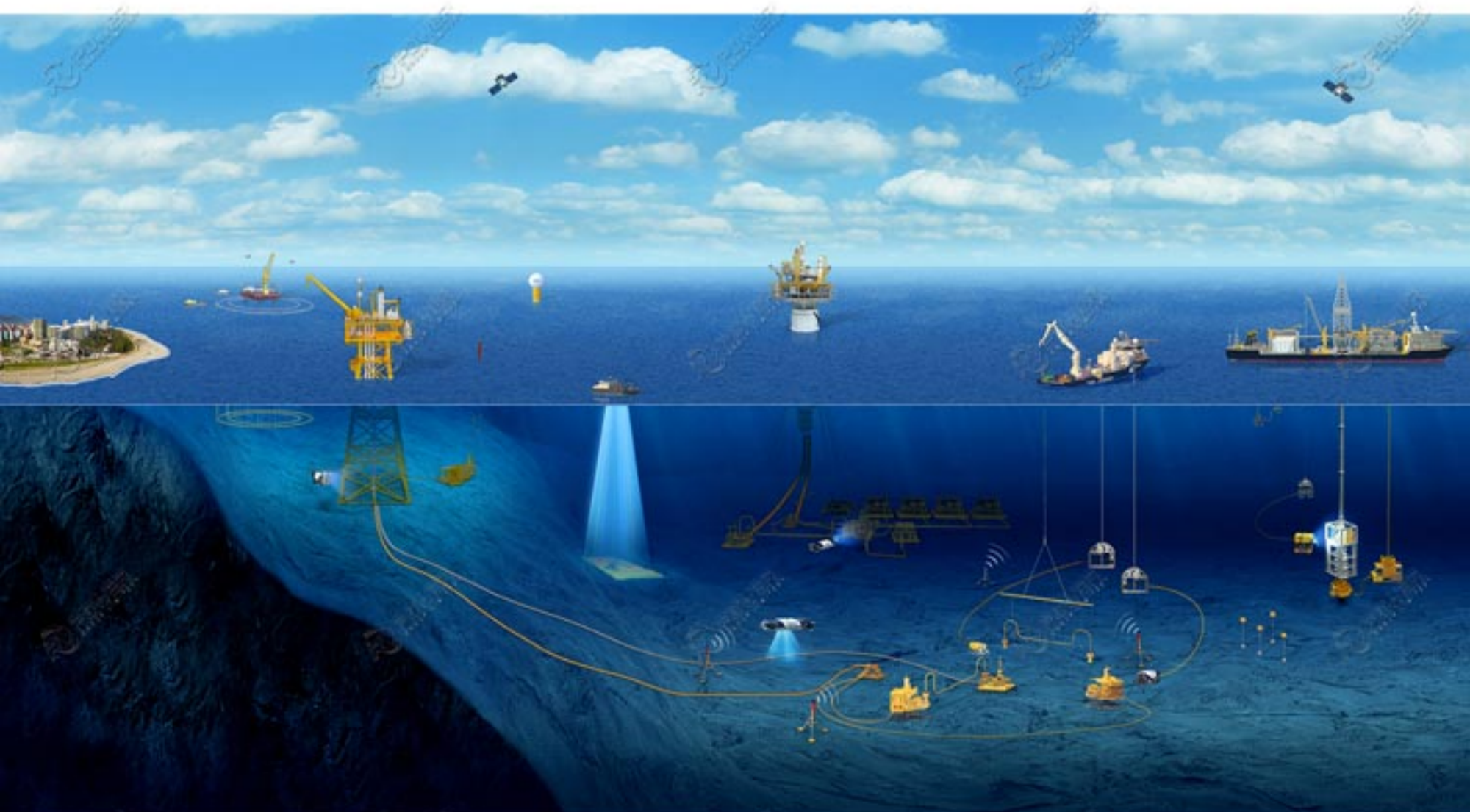
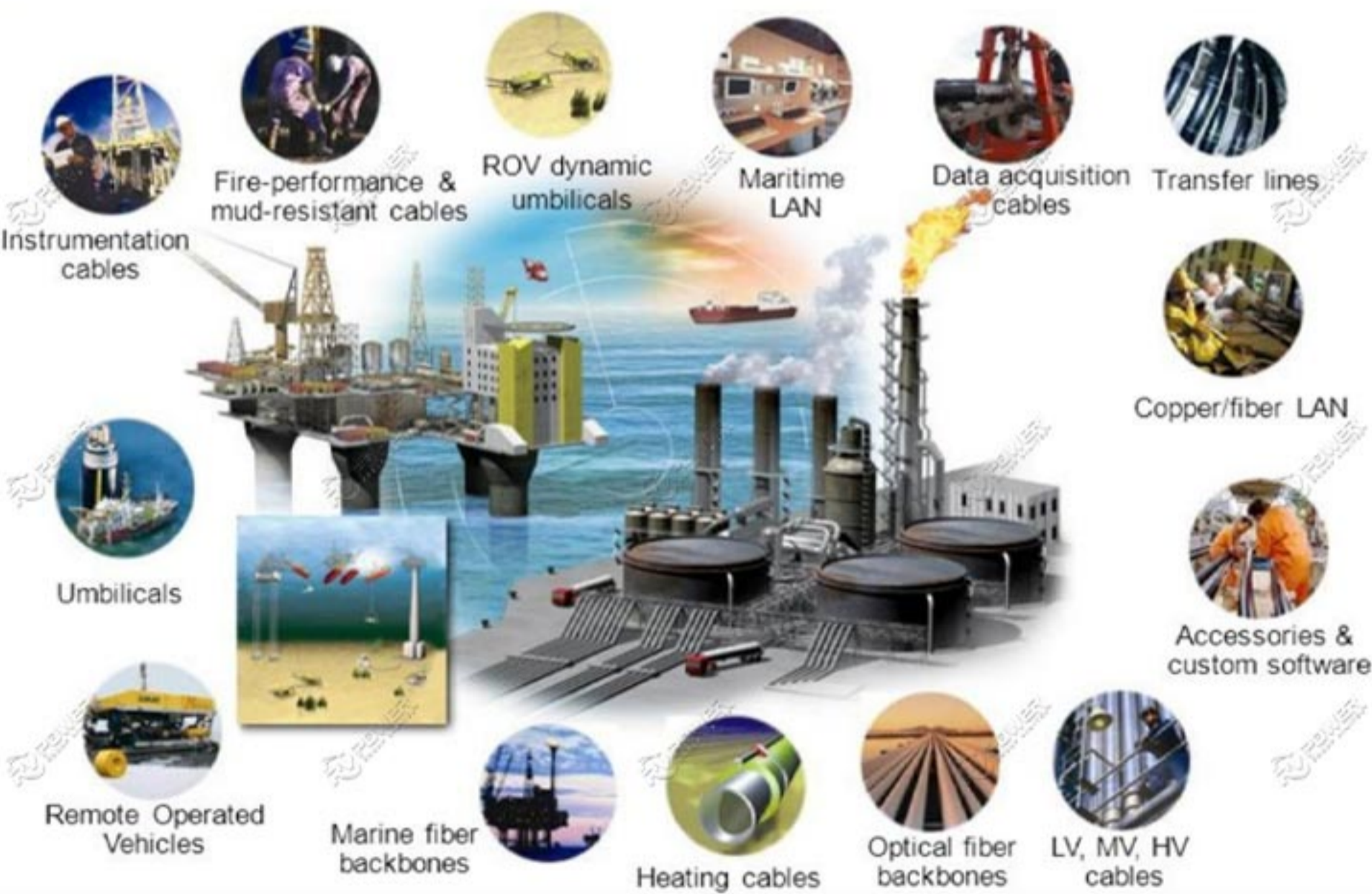

MICRO CIRCULAR SERIES UNDERWATER AND HARSH ENVIRONMENT CONNECTORS

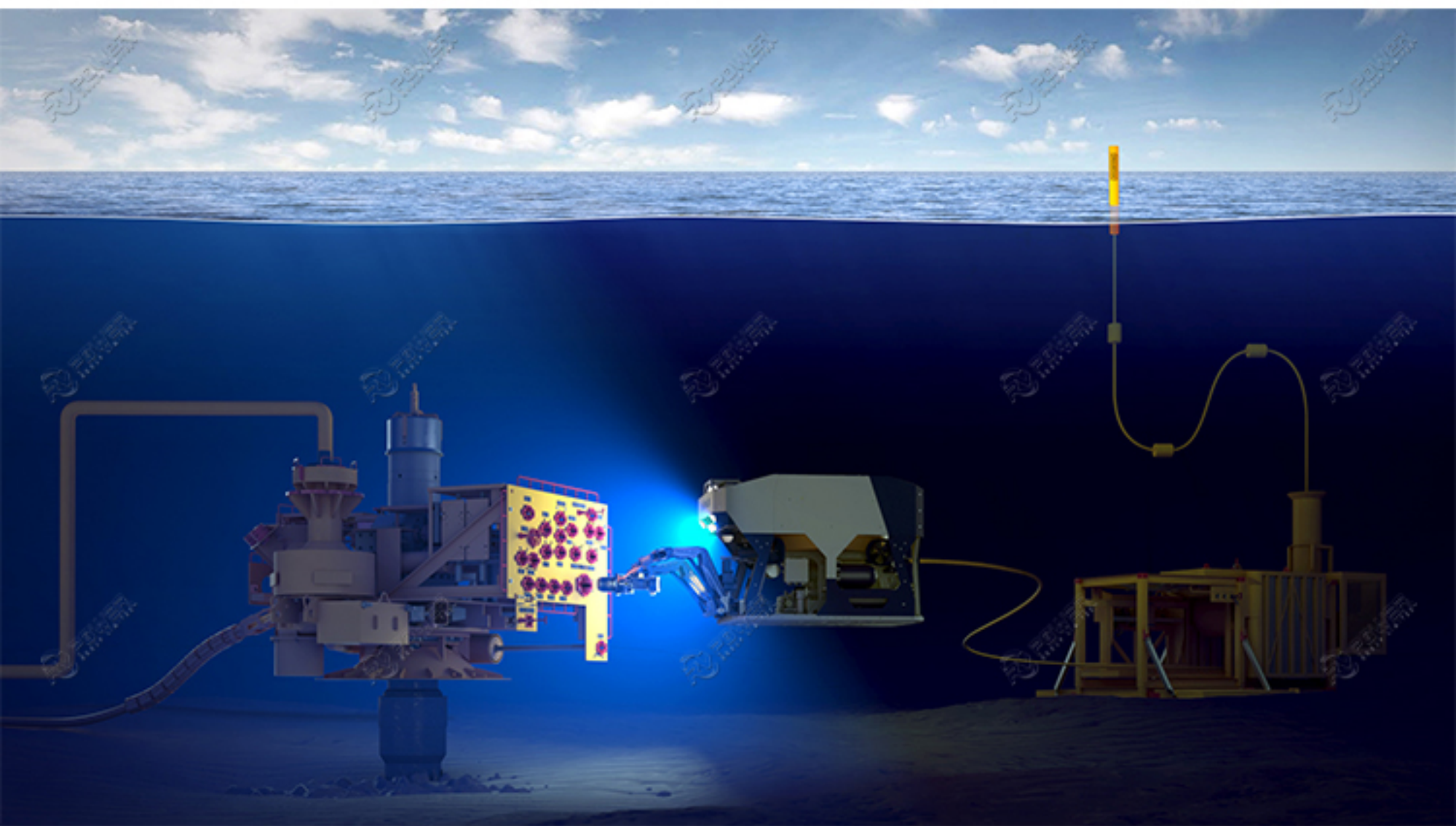

DETAIL DISPLAY



ONE



high-performance, dependable connector solution to accommodate the ever growing power requirements of underwater system operators and industries

TWO

includes a single contact power connector, three battery charging connectors (2, 3 and 4 contacts) and a 4-contact high power connector



THREE



a selection of cable sizes and can be operated at up to 3 kV and 250 A

FOUR

supplied in standard inline and bulkhead configurations.



FIVE



The 4-contact high power connector is suitable for 600 V at 50 A per contact



OIL RESISTANT



FLAE RESISTANT



HALOGEN FREE



COLD RESISTANT



ABRASION RESISTANT



OZONE RESISTANT



UV RESISTANT



MICROBE RESISTANT



MUD RESISTANT



WATER RESISTANT

OVER 20 YEARS

OF SPECIAL CABLE AND CUSTOM-MADE CABLE / CONNECTORS MANUFACTURING

WE CAN TURN YOUR DESIGN INTO A REAL OBJECT.

OUR TRANSPORTATION



THANK YOU

FOR YOUR ATTENTION
LOOK FORWARD TO COOPERATING WITH YOU



www.underwaterconn.com



sales@underwaterconn.com



Jackiefanonline88



Tel:+86 18501648956



Whatsapp: +86-18501648956



specialcable